



HOUSTON

**TrailView COLLECTION
MANUAL**

Frame Options, Specs & Ordering Code

Inside (IM) and Outside Mount (OM) L Frames

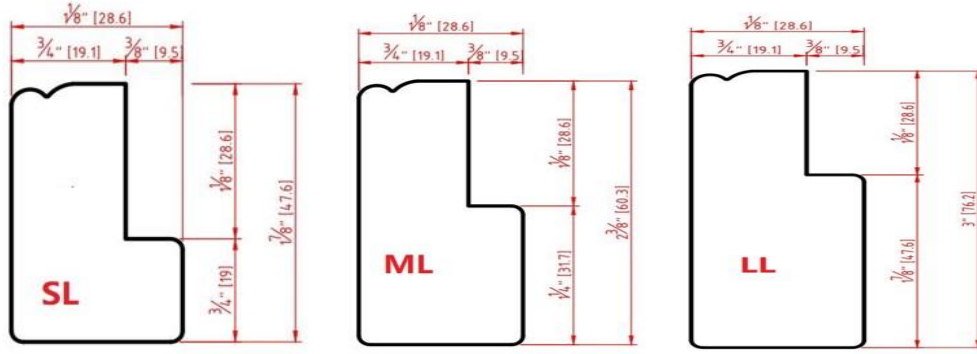

Small L Frame (SL)

Medium L Frame (ML)

Large L Frame (LL)

ADDITIONS

Frame Type	4 sided	4 sided w/ sill	4STB
SD (W)	ADD 3 1/4	ADD 3 1/4	ADD 3 1/4
SD (H)	ADD 3 1/4	ADD 1 5/8	- 1/8
LD (W)	ADD 4	ADD 4	ADD 4
LD (H)	ADD 4	ADD 2	- 1/8
SL (W)	ADD 2 1/4	ADD 2 1/4	ADD 2 1/4
SL (H)	ADD 2 1/4	ADD 1 1/8	- 1/8
ML (W)	ADD 2 1/4	ADD 2 1/4	ADD 2 1/4
ML (H)	ADD 2 1/4	ADD 1 1/8	- 1/8
LL (W)	ADD 2 1/4	ADD 2 1/4	ADD 2 1/4
LL (H)	ADD 2 1/4	ADD 1 1/8	- 1/8

Inside Mount Z Frame (IM)

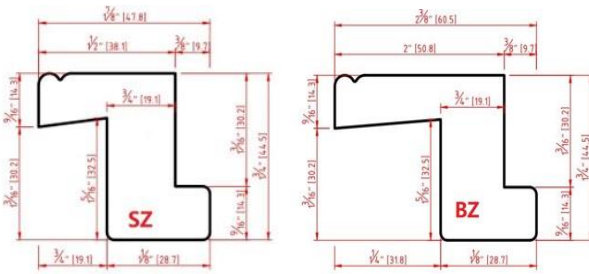

Small Z Frame (SZ)

Beaded Z Frame (BZ)

DEDUCTIONS

Frame Type	4	4S	4STB	T3	CAFÉ
L Frame Width	- 1/8	- 1/8	- 1/8	- 1/8	- 1/8
L Frame Height	- 1/8	N/A	N/A	- 1/8	0
Z Frame Width	- 3/8	- 3/8	- 3/8	- 3/8	- 3/8
Z Frame Height	- 3/8	- 3/8	- 1/8	- 3/8	0
No Frame Width	- 3/16	N/A	N/A	N/A	N/A
No Frame Height	- 3/16	N/A	N/A	N/A	N/A

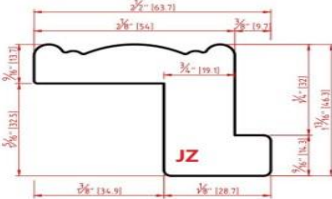

Jamestown Z Frame (JZ)

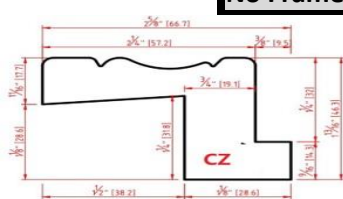

Colonial Z Frame (CZ)

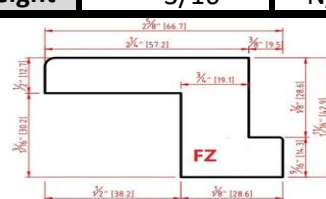

Flat Z (FZ)

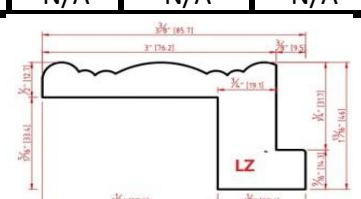

Large Z Frame (LZ)

Outside Mount (OM) Deco Frame

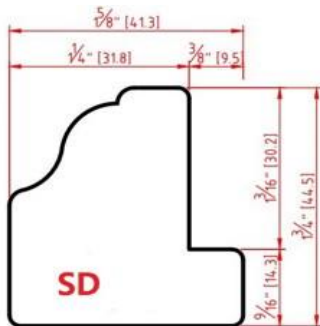

Small Deco (SD)

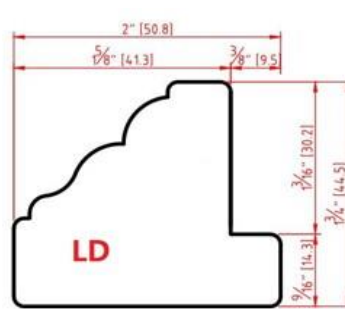

Large Deco (LD)

Build Out

Please note Start and Sides in Special Instructions

3/4"	1/2"	TBD	TBD
Standard Build Out (BO) not attached.		Custom Build out (CBO) not attached	

Attached to Frame (BOA)

Attached to Frame (CBOA)

T-Post

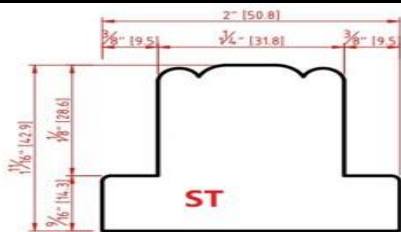

Small T-Post (ST)

Fill in the T-Post Columns on Measure Request and Order Forms With ST and Location.

Light Strip

No Frame or Light Stop

1/2"



3/4"

When ordering Light strip check the Light Strip box on the Order Form and the Sides that you will need.

EX: LTRB = all Sides

PANEL COMPONENTS AND LIMITATIONS

LOUVER SIZES

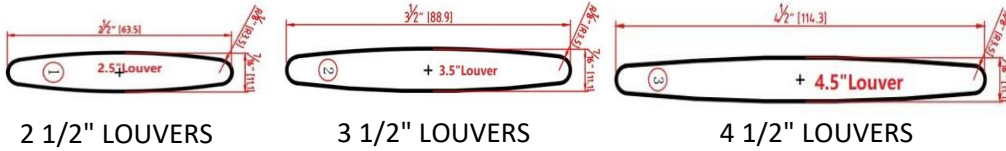

CLEARANCE

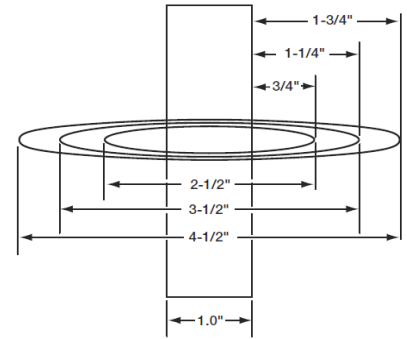

When Measuring for Hidden Tilt Add An Additional 1/4" to depth needed.

STILE

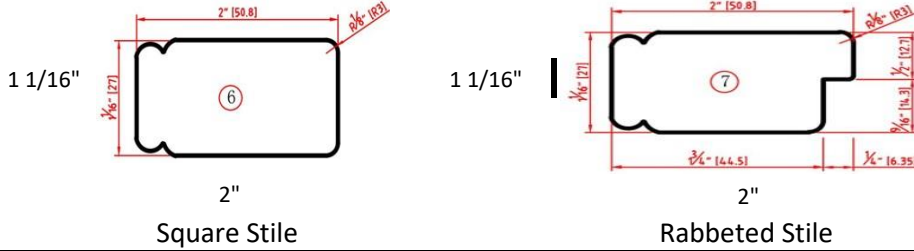

DIVIDER RAILS

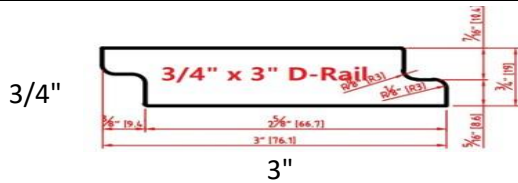

Used with 3.5" LOUVERS

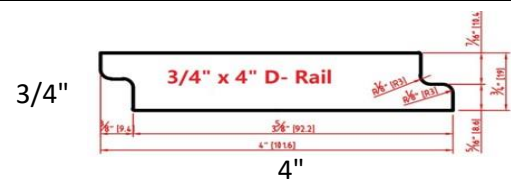

Used with 2.5" & 4.5" Louvers

CONTROLS

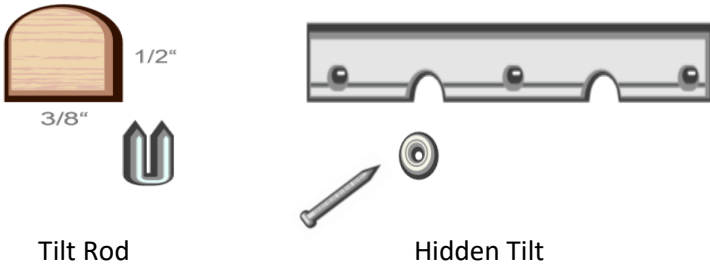

HINGE (NON-MORTISE)

Code Color

WH	White
OFF	Off White
PRL	Pearl
TN	Tan
BBS	Bright Brass
ABS	Antique Brass
ORB	Oil Rubbed Bronze
CHR	Chrome
NIC	Brushed Nickel

FACTORY HINGE COLORS (Match)

SW7006	WH	
SW7005	WH	
TX101	WH	ST401
TX102	WH	ST402
TX103	WH	ST403
TX104	PRL	ST404
TX105	OFF	ST405
TX106	OFF	ST406
TX107	OFF	ST407
TX108	OFF	ST501
TX109	OFF	ST502
TX110	OFF	ST503
TX111	TN	ST504
TX112	TN	ST505
TX113	TN	ST506
TX114	TN	ST507
TX115	TN	ST601
TX116	TN	ST602
TX117	TN	ST603
TX118	TN	ST604
TX119	TN	ST605
TX120	TN	ST606

MUST SPECIFY ON STAIN

Magnet Catch



Wood Panel Limitations

Divider Rail	2 1/2"	66"
	3 1/2"	72"
	4 1/2"	72"
Hidden-Tilt Split Requirements (Hidden Tilt Only)	2 1/2"	46"
	3 1/2"	60"
	4 1/2"	60"
Panel Folds	Width	Height
Single	7"-36"	Paint - 144"
Bi-Fold	7"-42"	Stain - 120"

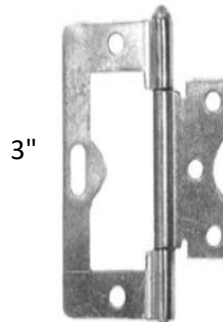

1-3/8"



How to Measure

Inside Mount (IM) Measurements

Provide the Smallest opening measurements. Inside Deductions will be shown on contract and drawings as a NWF.

OUTSIDE MOUNT (OM) Measurements

Provide the Largest opening measurement. Outside Additions will be shown on contract and drawings as a NWF.

Net With Frame (NWF) Measurements

Provide the Maximum Width and Height. Shutter will be made to exact measurement from tip to tip.

FRAME NOTCHING & BUILD OUT

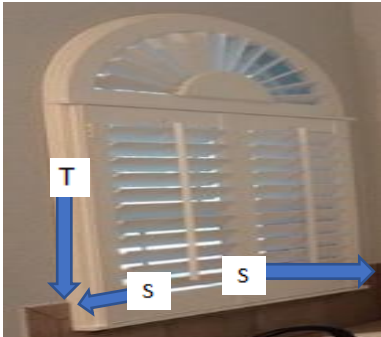
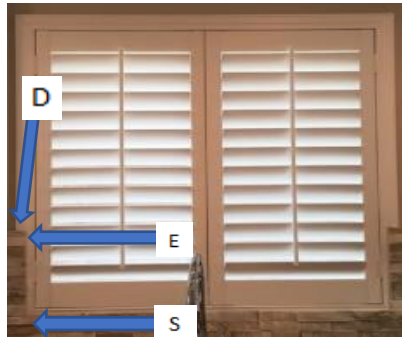
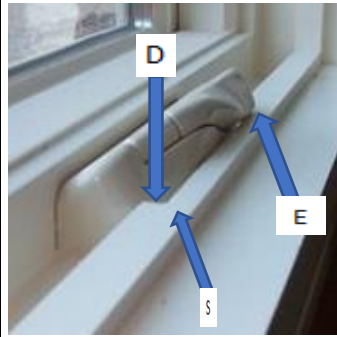

Window Crank Handle Notch
\$50.00 Per Opening
 Always Measure from the Left side of opening. Start (S) point, End (E) point and Depth (D).
 EX: S:10" E:15" D:3/8

Z Frame Notching For Tile
\$50.00 Per Opening
 Provide Side (Left, Right, Top, Bottom) Start (S) point, End (E) point and Depth (D).
 EX: L S: 0" E:9-7/8" D: 3/4"

Deco & Z Build Out
Back of Frame
 Provide Side (Left, Right, Top, Bottom) Start (S) point, and Thickness (T).
 EX: Left Right Top S:2-1/2" L 2-3/8" R T:3/8"

L Frame Build Out
Side of Frame
 Start (S) point, End (E) point and Thickness (T) Width (W).
 EX: S:8-5/8" Left & Right E: 34-1/2" T: 3/8"

FRAME SIDE CODE



4 Sided (4)
 Frame on all four sides

4 Sided w/ Sill cut Bottom (4S).
Z Frame
 Flange cut off of the frame.

Deco Frame
 3/4" cut off on both deco frames

4 Sided w/ sill cut top & Bottom (4STB). 3/4" cut off on both deco frames on TOP & BOTTOM

3 Sided w/ no bottom (T3).
 Frame on Left Right and Top.

3 sided w/ no top (CAFÉ).
 Frame on Left Bottom and Right.

NO FRAME DIRECT MOUNT

Ameritex Shutters provides two ways that Direct Mount Shutter can be ordered.

1. Provide Ameritex Shutters with the exact window opening labeled as a IM and we will deduct 3/16" Total.

2. Provide Ameritex Shutters with the measurement you would like the panel to be and mark the NWF box. Ameritex Shutters will make your panel that exact size.

If you select Direct Mount please check box on measure request and order forms if you would like light strips to be provided with the panel.



DOUBLE HUNG



Provide the Split measurement in the special instructions section of measure request and order forms.

ADDITIONAL MANUFACTURING CHARGES

CUSTOM PAINT MATCH

\$1.00 per sqft (Additional 1 time Surcharge of \$150.00 per order).
A sample of the paint will need to be provided if it is NOT a Sherwin Williams Color Number. Ameritex Shutters will send a Paint sample to the dealer for verification and approval.

CUSTOM STAIN MATCH

\$2.00 per sqft (Additional 1 time Surcharge of \$150.00 per order).
A sample of the stain will need to be provided if it is NOT a Sherwin Williams Color Number. Ameritex Shutters will send a Stain sample to the dealer for verification and approval.

ARCH WINDOWS



Eyebrow Arch (EYE)

True Radius/Perfect Arch (AR)

Full Rake Shutter (RK)

1/2 Rake Left (RK L)

1/2 Rake Right (RK R)

SPECIALTY ARCH

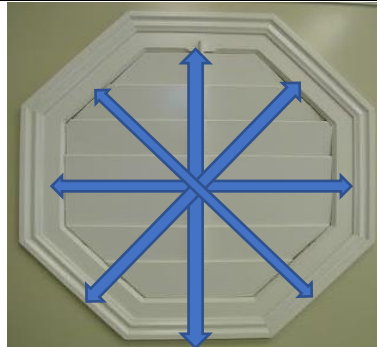
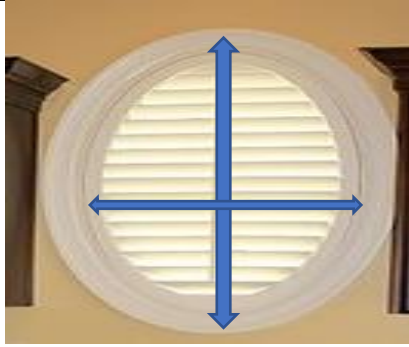

How to Price Specialty Shape (Circle, Oval, Octo, etc....):
Arch sqft \$ x 2. Minimum 5sqft.

Circle Shutter (Circle)

Oval Shutters (Oval)-
Please provide a template

Octagon Shutter (Octo)-
Please provide a template



MEASURE AND INSTALL SURCHARGES



BAY WINDOW
\$150.00 Per Bay



DIRECT MOUNT
\$25.00 Per opening

Tall Ladder- Windows that the top of the opening is 12 FT or greater in Height.

Blind Removal- The removal of Blinds & Shades for shutters to be installed. Disposal included.

Shutter Removal- The removal of Shutters so new shutters can be installed. Disposal included.

Moving Furniture- Ameritex Shutters installers will not move furniture without responsibility waiver signed.

High Rise- Please note on Measure request and order form if the Shutter needs to be assembled on site.

Temp Shades- Check box on the Measure request on which windows you would like covered. This must be done at time of measure.

Drapery Removal- Place quantity in the box on Measure Request and Order Forms.

CHAIR RAIL NOTCHING

TILE INSTALLATION



Ameritex installers will cut the Chair Rail. No Additional Charge.



Tile installation

REMOVAL DISCLOSURE

There is a risk of damage when removing Blinds, Shades, Shutters and Drapes due to screws and/or nails attaching the window covering to the wall. We will do our best to minimize damage, However we will not be responsible to any repairs costs associated with the removal.

WILL CALL

FOAM WRAP



WILL CALL ONLY
NO ADDITIONAL CHARGE

PACKAGE FOR TRANSPORT



WILL CALL & DELIVERY
Comes with Foam Wrap. Check the Package for Transport box on Order Form.



ADDITIONAL MANUFACTURING CHARGES FRENCH DOOR CUTOUTS

ALL DIMENSIONS ARE NWF SIZE, BASED ON SHUTTER

Half Circle Cut Out

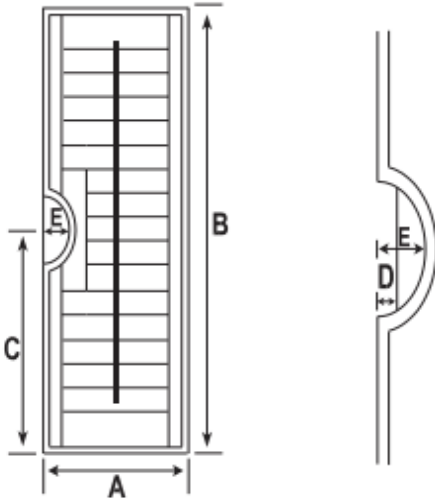

Rectangular Cut Out

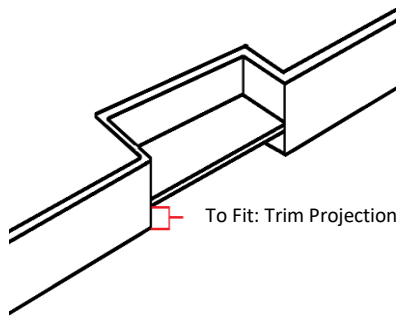
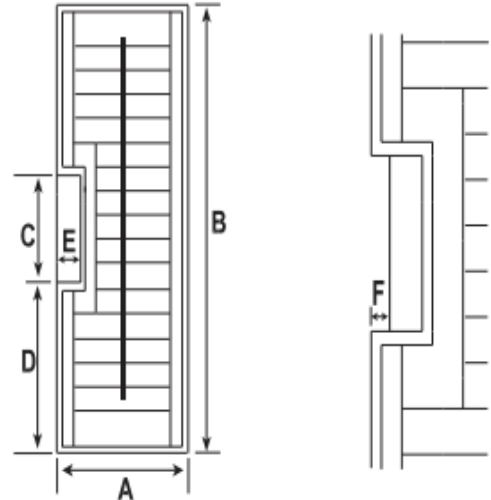

TRIM PROJECTION:
Plate inside of the cut out
will be raised to avoid
trim

A= _____ Shutter width, Frame to Frame
 B= _____ Shutter Height, Frame to Frame
 C= _____ Center Of Cut Out, From Bottom OF Shutter
 D= _____ Recessed Plate To Fit Handle/Doorknob Base
 E= Radius: 5" x 10"
 Build Out: 1/2" 1"
 Trim Projection: _____

A= _____ Shutter width, Frame to Frame
 B= _____ Shutter Height, Frame to Frame
 C= _____ Cut Out Height
 D= _____ From Bottom Frame to Bottom of Cut Out
 E= _____ Cut Out Width
 F= _____ Recessed Plate To Fit Hand/Doorknob Base
 Build Out: 1/2" 1"
 Trim Projection: _____

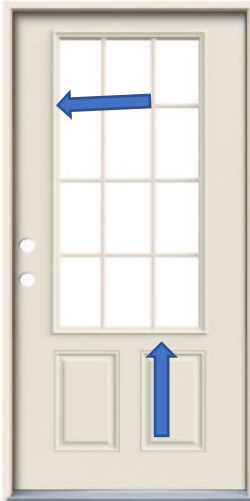

**Lever Handle
Round Door Cutout**

**Blue Arrows
Pointing at Bevel**

**Round Door Knob
No Cut Out**

**Lever Handle
Square Cut Out**

If the Door has a bevel (Picture Above) Ameritex Shutters measures the Tip to Tip width and height of the bevel (Door With Blue Arrows). Which makes these applications **NWF** on the order sheet. **Make sure that you are aware of what door handles are on the door or will be installed if handles are not present.**