

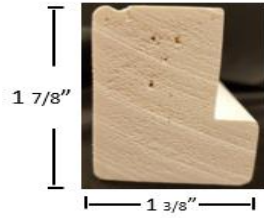

LAKEVIEW COLLECTION MANUAL

Frame Options, Specs & Ordering Code

Inside (IM) and Outside Mount (OM) L Frames



Small L Frame (PSL)

Inside Mount Z Frame (IM)

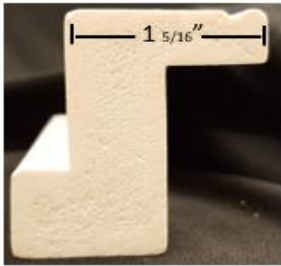

Trim Z Frame (PTZ)

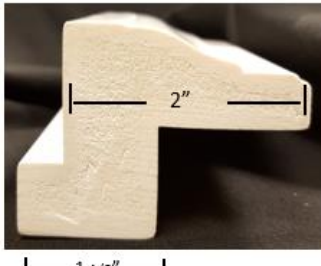

Regal Z Frame (PRZ)

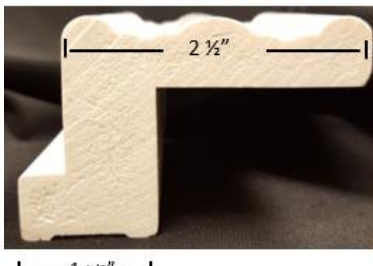

Medium Z Frame (PMZ)

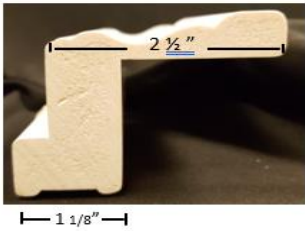

Colonial Z Frame (PCZ)

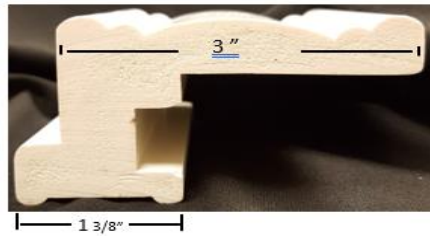

Large Z Frame (PLZ)

Outside Mount (OM) Deco Frame

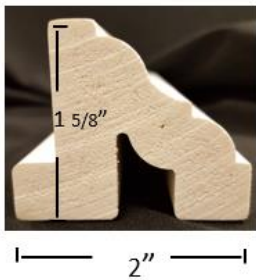

Small Deco (PDeco)

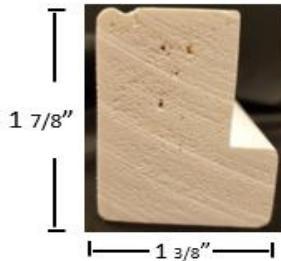

Small L Frame (PSL)

T-Post

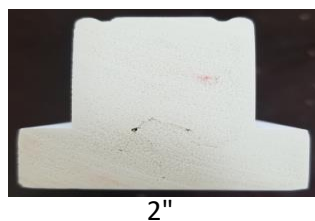

T-Post (PT)

ADDITIONS

Frame Type	4sided	4 sided w/ sill	4STB
PD (W)	ADD 4	ADD 4"	ADD 4"
PD (H)	ADD 4"	ADD 2"	- 1/8
PSL (W)	ADD 2 3/4"	ADD 2 3/4"	ADD 2 3/4"
PSL (H)	ADD 2 3/4"	ADD 1 3/8"	- 1/8

DEDUCTIONS

Frame Type	4sided	4 sided w/ sill	4STB
PTZ (w)	- 1/4	- 1/4	- 1/4
PTZ (H)	- 1/4	- 1/4	- 1/8
PRZ (W)	- 3/8	- 3/8	- 3/8
PRZ (H)	- 3/8	- 3/8	- 1/8
PMZ (W)	- 3/8	- 3/8	- 3/8
PMZ (H)	- 3/8	- 3/8	- 1/8
PLZ (W)	- 3/8	- 3/8	- 3/8
PLZ (H)	- 3/8	- 3/8	- 1/8
PCZ (W)	- 3/8	- 3/8	- 3/8
PCZ (H)	- 3/8	- 3/8	- 1/8
PSL (W)	- 1/8	N/A	N/A
PSL (H)	- 1/8	N/A	N/A

Build Out

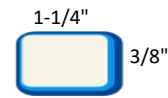

Standard Build Out
(BO)
not attached.

NO CUSTOM BUILD OUT IN
LAKEVIEW

Attached to Frame
(BOA)

PANEL COMPONENTS AND LIMITATIONS

LOUVER SIZES



2 1/2" LOUVERS



3 1/2" LOUVERS

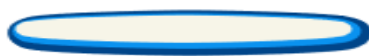

4 1/2" LOUVERS



2 1/2" LOUVERS



3 1/2" LOUVERS



4 1/2" LOUVERS

REINFORCED LOUVERS: Greater than 24" Panel

STILE



Square Stile

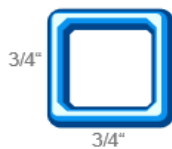

Aluminum Core



Rabbeted Stile

CLEARANCE

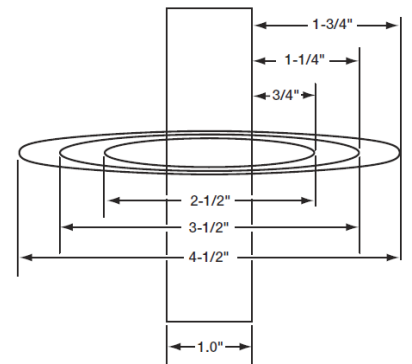

Depths needed for Louvers

When Measuring for Hidden Tilt Add An Additional 1/4" to depth needed.

DIVIDER RAILS

3/4"

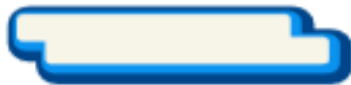

3-1/4"

Used with all Louvers

HINGE (NON-MORTISE)

Code Color

- WH White
- OFF Off White
- PRL Pearl
- TN Tan

FACTORY HINGE COLORS (Match)

- | | |
|---------------|-----------|
| Snow White | White |
| White | White |
| Classic White | Off White |

- BBS Bright Brass
- ABS Antique Brass
- OLB Oil Rubbed Bronze
- CHR Chrome
- NIC Brushed Nickel

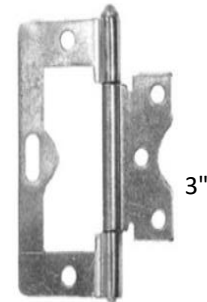

1 3/8"

3"

CONTROLS



Tilt Rod

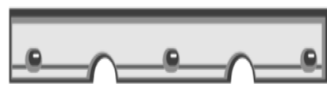

Hidden Tilt

Magnet Catch



Magnet



Strike Plate

LakeView Panel Limitations

Panel Size Divider Rail Requirements		Hidden-Tilt Split Requirements (Hidden Tilt Only)		Single Fold	
				Width	Height
2 1/2"	48"	2 1/2"	46"	7" - 30"	120"
3 1/2"	66"	3 1/2"	60"	Bi-Fold	
4 1/2"	66"	4 1/2"	60"	Width	Height
				7" - 30"	120"

How to Measure

Inside Mount (IM) Measurements

Provide the smallest opening measurements. Inside Deductions will be shown on contract and drawings as a NWF.

OUTSIDE MOUNT (OM) Measurements

Provide the Largest opening measurement. Outside Additions will be shown on contract and drawings as a NWF.

Net With Frame (NWF) Measurements

Provide the Maximum Width and Height. Shutter will be made to exact measurement from tip to tip.

FRAME NOTCHING & BUILD OUT

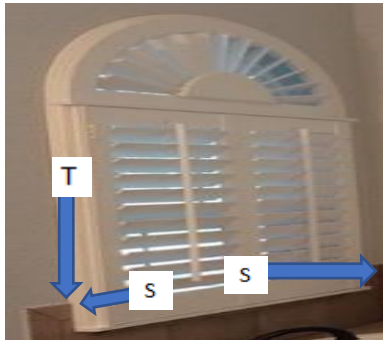
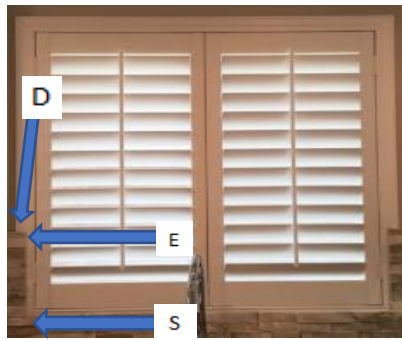
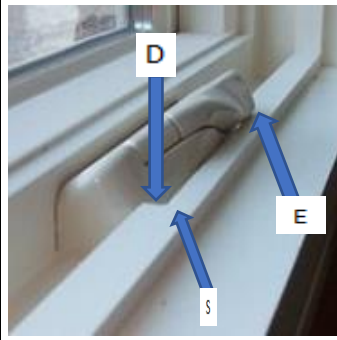

Window Crank Handle Notch
\$50.00 Per Per Opening
 Always Measure from the Left side of opening. Start (S) point, End (E) point and Depth (D).
 EX: S:10" E:15" D:3/8

Z Frame Notching For Tile
\$50.00 Per Per Opening
 Provide Side (Left, Right, Top, Bottom) Start (S) point, End (E) point and Depth (D).
 EX: L S: 0" E:9-7/8" D: 3/4"

Deco & Z Build Out
Back of Frame
 Provide Side (Left, Right, Top, Bottom) Start (S) point, and Thickness (T).
 EX: Left Right Top S:2-1/2"L 2-3/8"R T:3/8"

L Frame Build Out
Side of Frame
 Start (S) point, End (E) point and Thickness (T) Width (W).
 EX: S:8-5/8"Left & Right E: 34-1/2" T: 3/8"

FRAME SIDE CODE

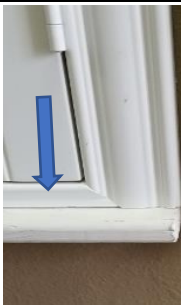

4 Sided (4)
 Frame on all four sides

4 Sided w/ Sill cut Bottom (4S).
Z Frame
 Flange cut off of the frame.

4 Sided w/ sill cut top & Bottom (4STB).
 3/4" cut off on both deco frames on TOP & BOTTOM

3 Sided w/ no bottom (T3).
 Frame on Left Right and Top.

3 sided w/ no top (CAFÉ).
 Frame on Left Bottom and Right.

NO FRAME DIRECT MOUNT

Ameritex Shutters provides two ways that Direct Mount Shutter can be ordered.

1. Provide Ameritex Shutters with the exact window opening labeled as a IM and we will deduct 3/16" Total.

2. Provide Ameritex Shutters with the measurement you would like the panel to be and mark the NWF box. Ameritex Shutters will make your panel that exact size.

If you select Direct Mount please check box on measure request and order forms if you would like light strips to be provided with the panel.

DOUBLE HUNG



Provide the Split measurement in the special instructions section of measure request and order forms.

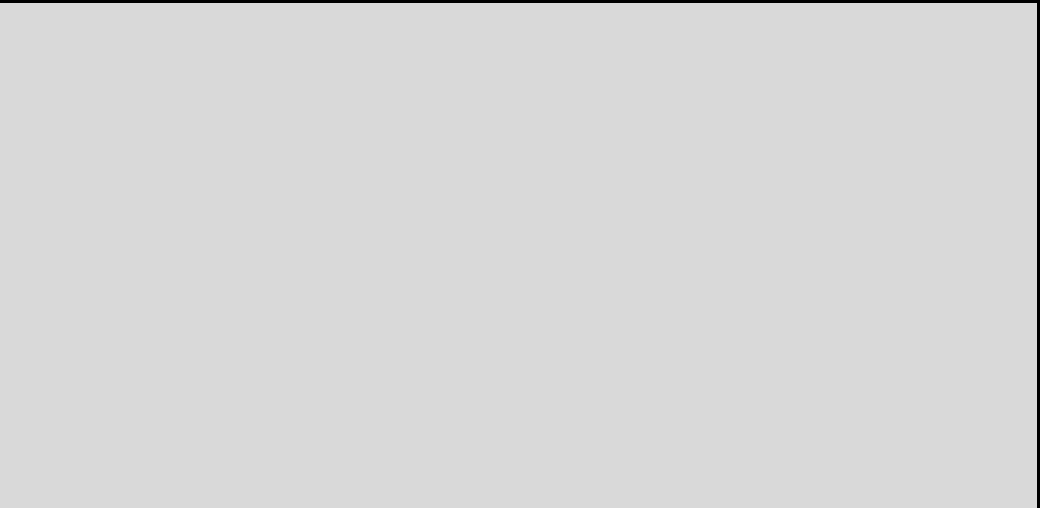

ARCH WINDOWS



Eyebrow Arch (EYE)

True Radius/Perfect Arch (AR)

Full Rake Shutter (RK)

1/2 Rake Left (RK L)

1/2 Rake Right (RK R)

SPECIALTY ARCH

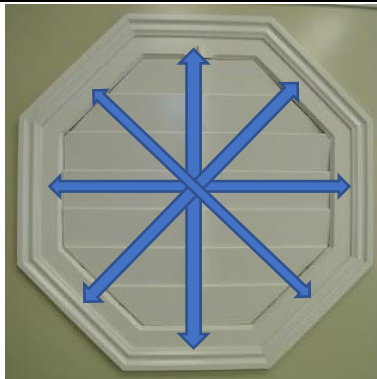
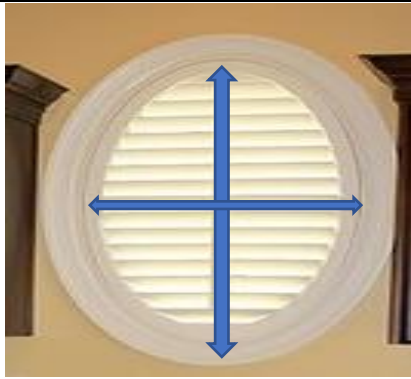

Circle Shutter (Circle)

**Oval Shutters (Oval)-
Please provide a template**

**Octagon Shutter (Octo)-
Please provide a template**

**How to Price Specialty Shape (Circle, Oval, Octo, etc....):
Arch sqft \$ x 2. Minimum 6sqft.**

ADDITIONAL MANUFACTURING CHARGES

FRENCH DOOR CUTOUTS

ALL DIMENSIONS ARE NWF SIZE, BASED ON SHUTTER

Half Circle Cut Out

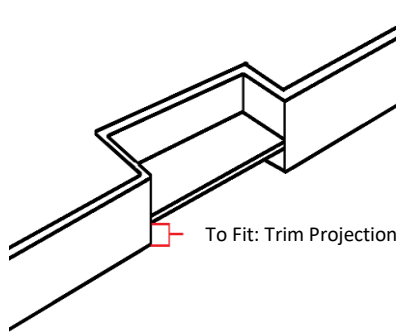
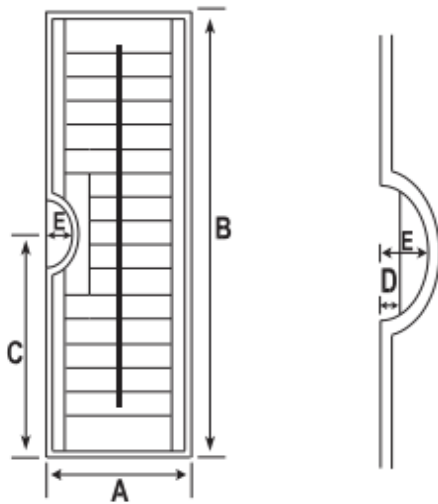

TRIM PROJECTION:
Plate inside of the cut out
will be raised to avoid
trim

Rectangular Cut Out

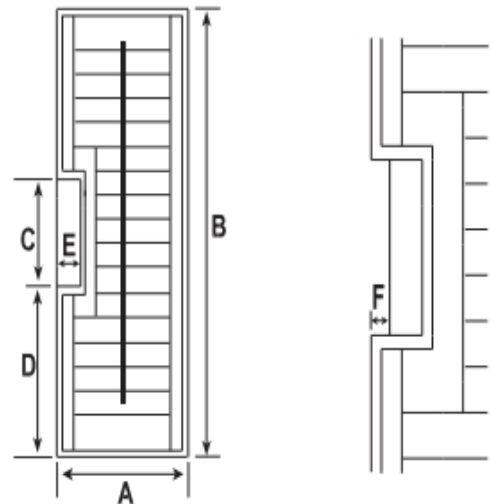

A= _____ Shutter width, Frame tc Frame
 B= _____ Shutter Height, Frame tc Frame
 C= _____ Center Of Cut Out, From Bottom OF Shutter
 D= _____ Recessed Plate To Fit Handle/Doorknob Base
 E= Radius: 5"
 Build Out: 1/2" 1"
 Trim Projection: _____

A= _____ Shutter width, Frame tc Frame
 B= _____ Shutter Height, Frame tc Frame
 C= _____ Cut Out Height
 D= _____ From Bottom Frame to Bottom of Cut Out
 E= _____ Cut Out Width
 F= _____ Recessed Pate To Fit Hand/Doorknob Base
 Build Out: 1/2" 1"
 Trim Projection: _____

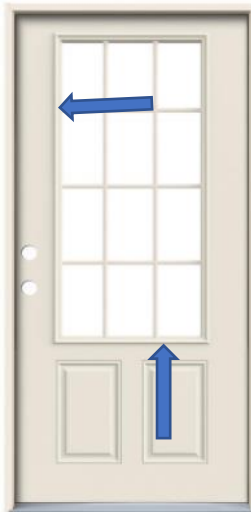

Lever Handle
Round Door Cutout

Blue Arrows
Pointing at Bevel

Round Door Knob
No Cut Out

Lever Handle
Square Cut Out

If the Door has a bevel (Picture Above) Ameritex Shutters measures the Tip to Tip width and height of the bevel (Door With Blue Arrows). Which makes these applications **NWF** on the order sheet. **Make sure that you are aware of what door handles are on the door or will be installed if handles are not present.**



MEASURE AND INSTALL SURCHARGES



BAY WINDOW



DIRECT MOUNT

Tall Ladder - Windows that the top of the opening is 12 FT or greater in Height.

Blind Removal- The removal of Blinds & Shades for shutters to be installed. Disposal included.

Shutter Removal- The removal of Shutters so new shutters can be installed. Disposal included.

Moving Furniture- Ameritex Shutters installers will not move furniture without responsibility waiver signed.

High Rise- Please note on Measure request and order form if the Shutter needs to be assembled on site.

Temp Shades- Check box on the Measure request on which windows you would like covered. This must be done at time of measure.

Drapery Removal- Place quantity in the box on Measure Request and Order Forms.

CHAIR RAIL NOTCHING

TILE INSTALLATION



Ameritex installers will cut the Chair Rail. No Additional Charge.



Tile installation

REMOVAL DISCLOSURE

There is a risk of damage when removing Blinds, Shades, Shutters and Drapes due to screws and/or nails attaching the window covering to the wall. We will do our best to minimize damage, However we will not be responsible to any repairs costs associated with the removal.

WILL CALL

FOAM WRAP



WILL CALL ONLY
NO ADDITIONAL CHARGE

PACKAGE FOR TRANSPORT



WILL CALL & DELIVERY
Comes with Foam Wrap. Check the Package for Shipping box on Order Form.

Break Down For Shipping

Due to limits set by shipping companies. Ameritex Shutters will splice all frames that exceed 86" for shipping purposes.