

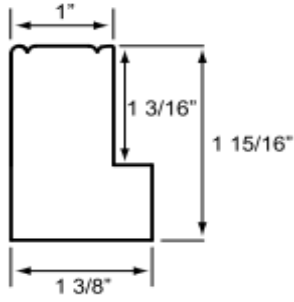

# **OCEANSIDE COLLECTION MANUAL**

**Inside (IM) and Outside Mount (OM) L Frames**



**L-Frame  
(LFI, LFO)**

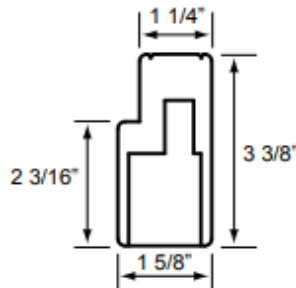

**\* Large L-Frame  
Surcharge (FFI, LLO)**

**Deductions**

Frame Type	Opening	NWF
LFI	- 1/8"	0
FFI	- 1/8"	0
MDZ	- 1/2"	0
LGZ	- 1/2"	0
MAZ	- 3/8"	0
2FZ	- 1/2"	0

**Inside Mount Z Frame (IM)**

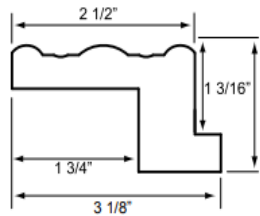

**Medium Z-Frame  
(MDZ)**

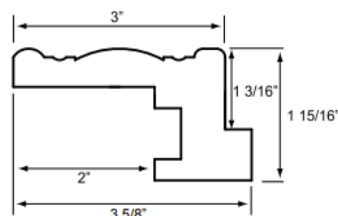

**Large Z-Frame  
(LGZ)**

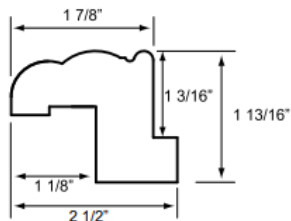

**Matagorda Z-Frame  
(MAZ)**

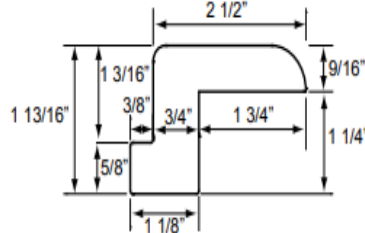

**2" Flat Z-Frame  
(2FZ)**

**ADDITIONS**

Frame Type	Opening	NWF
LFO	+ 3"	0
LLO	+ 3 1/2"	0
DSO	+ 4"	0
DFO	+ 6 1/2"	0
MFO	+ 4 1/2"	0

**Outside Mount (OM) Deco Frame**

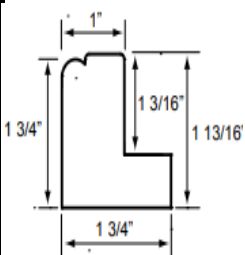

**Deco Sill Frame  
(DSO)**

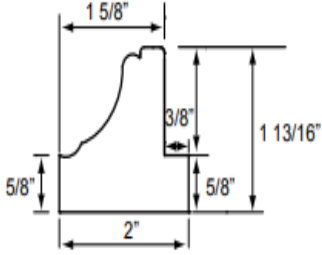

**Deco Frame  
(D2O)**

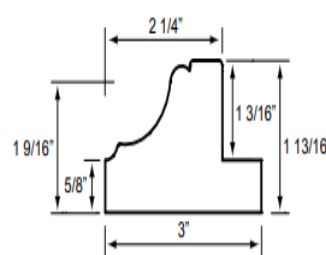

**3" Deco Frame  
(DFO)**

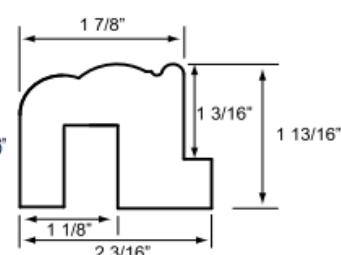

**\*Matagorda Frame  
Surcharge (MFO)**

**T-Post**

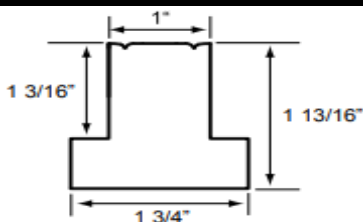

**Small T-Post  
(STP)**

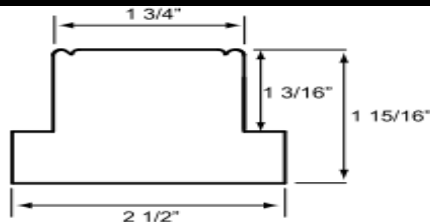

**Large T-Post  
(LTP)**

**Build Out**

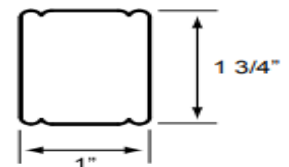

**Standard Build-Out  
(BO) 1/4" Minimum**

**PANEL COMPONENTS AND DEDUCTIONS**

**LOUVER SIZES**

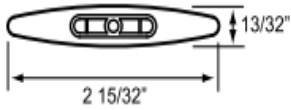

**2 1/2" LOUVERS**

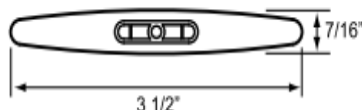

**3 1/2" LOUVERS**

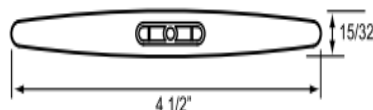

**4 1/2" LOUVERS**

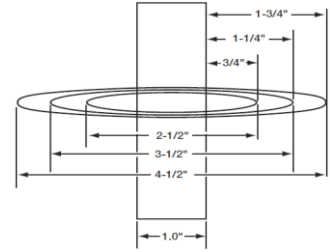

**Depths needed for Louvers**

When Measuring for Hidden Tilt Add An Additional 1/4" to depth needed.

**STILE**

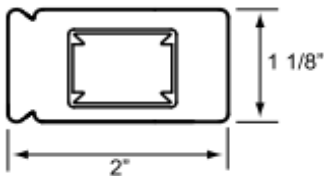

**Square Stile**

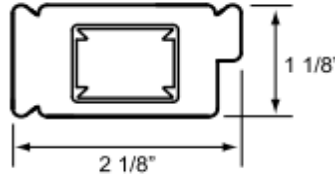

**Rabbeted Stile**

**TOP & BOTTOM RAILS**

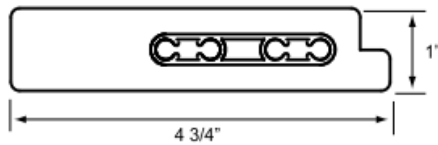

**DIVIDER RAIL**

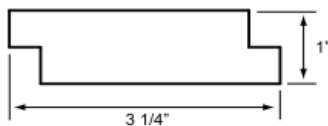

**CONTROLS**

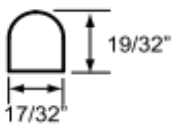

**Tilt Rod**



**Hidden Tilt**

**Magnet Catch**



**Magnet**



**Strike Plate**

**HINGE (NON-MORTISE)**

Code	Color
BRI	Bright White
DUL	Dull White
OFF	Off White
BBS	Bright Brass
ABS	Antique Brass
NIC	Nickel
OLB	Oil Rubbed Bronze

**FACTORY HINGE COLOR (Match)**

Shutter Color	Shutter Code	Hinge Code
Bright White	BRI	BRI
Dull White	DUL	DUL
Ultra White	ULT	BRI
Off White	OFF	OFF
Pearl White	PRL	DUL

**Wood Panel Limitations**

Divider Rail or Split Tilt	4 1/2"	<32"w-72"h
	3 1/2"	<32"w-72"h
	2 1/2"	<32"w-72"h
Panel Folds	Width	Height
Single	7"-36"	120"
Bi-Fold	7"-42"	120"

**FRAME Deductions**

**Inside Mount (IM) Measurements**

Provide the Smallest opening measurements.

**OUTSIDE MOUNT (OM) Measurements**

Provide the Largest opening measurement.

**Net With Frame (NWF) Measurements**

Provide the Maximum Width and Height.

**BUILD OUT**

**FRAME NOTCHING**

MountainSide Collection Build-out is only Manufactured two ways

**Attached**

**Non Attached**

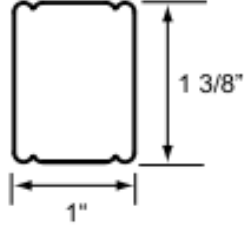
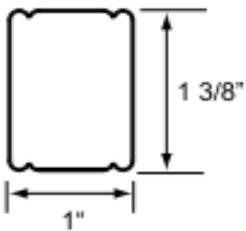

Attached on all 4 sides.  
Max Size in picture above.  
Min 1/4"

Max Size in picture above. Min 1/4"

**Frame Notching Not available in OceanSide Collection.**

**Frame Side Code**



**4 Sided (4)**  
Frame on all four sides

**4 Sided w/ Sill cut Bottom (4S).**  
Z Frame  
Deco Frame  
Flange cut off of the frame.  
  
Deco Sill rame (DSO)

**4 Sided w/ sill cut top & Bottom (4STB).** 3/4" cut off on both deco frames on TOP & BOTTOM

**3 Sided w/ no bottom (T3).**  
Frame on Left Right and Top.

**3 sided w/ no top (CAFÉ).**  
Frame on Left Bottom and Right.

**NO FRAME DIRECT MOUNT**

Ameritex Shutters provides two ways that Direct Mount Shutter can be ordered.

1. Provide Ameritex Shutters with the exact window opening labeled as a IM and we will deduct 3/16" Total.

2. Provide Ameritex Shutters with the measurement you would like the panel to be and mark the NWF box. Ameritex Shutters will make your panel that exact size.

If you select Direct Mount please note on order form if you would like light strips to be provided with the panel. Mark this in the frame Colom as (LS).

## DOUBLE HUNG



Provide the Split measurement in the special instructions section of measure request and order forms.

## ARCH WINDOWS



**Eyebrow Arch (EYE)**

**True Radius/Perfect Arch (AR)**

**Full Rake Shutter (RK)**

**1/2 Rake Left (RK L)**

**1/2 Rake Right (RK R)**

## SPECIALTY ARCH

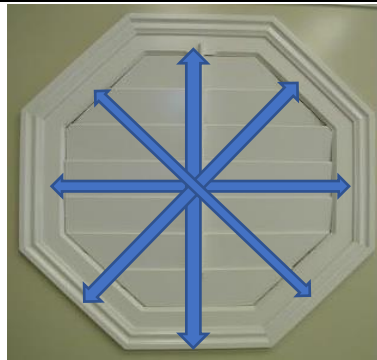
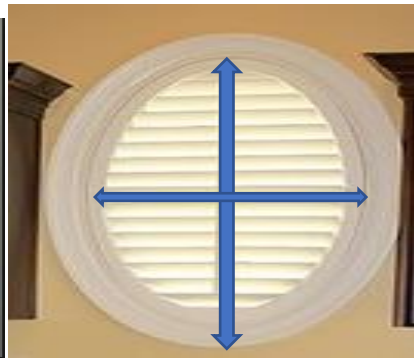

**Circle Shutter (Circle)**

**Oval Shutters (Oval)-  
Please provide a template**

**Octagon Shutter (Octo)-  
Please provide a template**

**How to Price Specialty Shape (Circle, Oval, Octo, etc....):**  
Arch sqft \$ x 2. Minimum 5sqft.



# MEASURE AND INSTALL SURCHARGES



**BAY WINDOW**  
\$150.00 Per Bay



**DIRECT MOUNT**  
\$25.00 Per opening

**Tall Ladder-** Windows that the top of the opening is 12 FT or greater in Height.

**Blind Removal-** The removal of Blinds & Shades for shutters to be installed. Disposal included.

**Shutter Removal-** The removal of Shutters so new shutters can be installed. Disposal included.

**Moving Furniture-** Ameritex Shutters installers will not move furniture without responsibility waiver signed.

**High Rise-** Please note on Measure request and order form if the Shutter needs to be assembled on site.

**Temp Shades-** Check box on the Measure request on which windows you would like covered. This must be done at time of measure.

**Drapery Removal-** Place quantity in the box on Measure Request and Order Forms.

## CHAIR RAIL NOTCHING

## TILE INSTALLATION



Ameritex installers will cut the Chair Rail. No Additional Charge.



Tile installation

## REMOVAL DISCLOSURE

There is a risk of damage when removing Blinds, Shades, Shutters and Drapes due to screws and/or nails attaching the window covering to the wall. We will do our best to minimize damage, However we will not be responsible to any repairs costs associated with the removal.

## FRENCH DOOR CUTOUTS

**ALL DIMENSIONS ARE NWF SIZE, BASED ON SHUTTER**

### Half Circle Cut Out

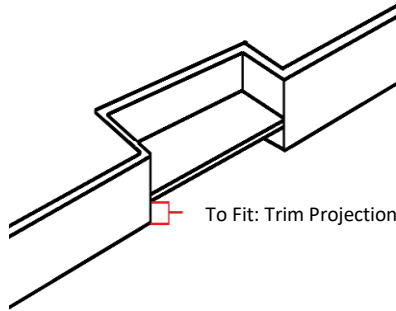
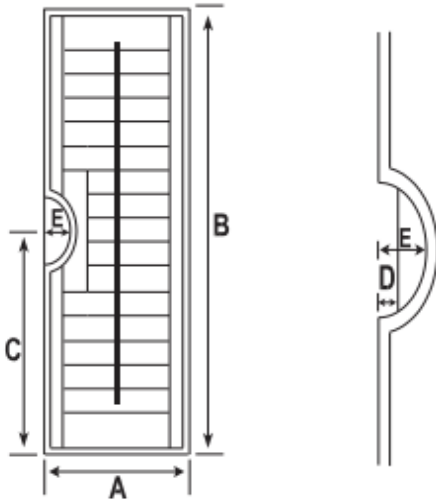

### Rectangular Cut Out

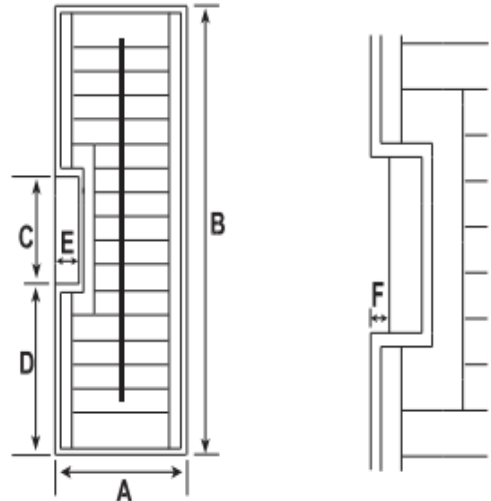

A= \_\_\_\_\_ Shutter width, Frame to Frame  
 B= \_\_\_\_\_ Shutter Height, Frame to Frame  
 C= \_\_\_\_\_ Center Of Cut Out, From Bottom OF Shutter  
 D= \_\_\_\_\_ Recessed Plate To Fit Handle/Doorknob Base  
 E= Radius: 5" x 10"  
 Build Out:  1/2"  1"  
 Trim Projection: \_\_\_\_\_

A= \_\_\_\_\_ Shutter width, Frame to Frame  
 B= \_\_\_\_\_ Shutter Height, Frame to Frame  
 C= \_\_\_\_\_ Cut Out Height  
 D= \_\_\_\_\_ From Bottom Frame to Bottom of Cut Out  
 E= \_\_\_\_\_ Cut Out Width  
 F= \_\_\_\_\_ Recessed Plate To Fit Hand/Doorknob Base  
 Build Out:  1/2"  1"  
 Trim Projection: \_\_\_\_\_



Lever Handle  
Round Door Cutout



Blue Arrows  
Pointing at Bevel



Round Door Knob  
No Cut Out



Lever Handle  
Square Cut Out

If the Door has a bevel (Picture Above) Ameritex Shutters measures the Tip to Tip width and height of the bevel (Door With Blue Arrows). Which makes these applications **NWF** on the order sheet. **Make sure that you are aware of what door handles are on the door or will be installed if handles are not present.**